

Description: User Manual LumiNode 12.
REVISION: 20220629-REV 2.4.1



LumiNode 12 USER MANUAL



LUMINODE PRODUCT FAMILY
LumiNode 12

THANKS FOR CHOOSING LUMINEX

MADE IN BELGIUM

General information



The lightning flash with arrowhead symbol, within an equilateral triangle, is intended to alert the user to the presence of uninsulated “dangerous voltage” within the product’s enclosure that may be of sufficient magnitude to constitute a risk of electric shock to persons.

L'éclair avec une flèche à l'intérieur d'un triangle équilatéral est destiné à attirer l'attention de l'utilisateur sur la présence d'une « tension dangereuse » non isolée à l'intérieur de l'appareil, pouvant être suffisamment élevée pour constituer un risque d'électrocution.



The exclamation point within an equilateral triangle is intended to alert the user to the presence of important operating and maintenance (servicing) instructions in the literature accompanying the appliance.

Le point d'exclamation à l'intérieur d'un triangle équilatéral est destiné à attirer l'attention de l'utilisateur sur la présence d'instructions importantes sur l'emploi ou la maintenance (réparation) de l'appareil dans la documentation fournie.

CAUTION

TO REDUCE THE RISK OF FIRE OR ELECTRIC SHOCK, DO NOT EXPOSE THIS APPARATUS TO RAIN OR MOISTURE.

AVERTISSEMENT

POUR RÉDUIRE LES RISQUES D'INCENDIE OU DE DÉCHARGE ÉLECTRIQUE, N'ÉPOSEZ PAS CET APPAREIL À LA PLUIE OU À L'HUMIDITÉ.

CAUTION

NO USER SERVICEABLE PARTS INSIDE. REFER SERVICING TO QUALIFIED SERVICE PERSONNEL.

AVERTISSEMENT

AUCUNE PIÈCE CONTENUE À L'INTÉRIEUR NE PEUT ÊTRE RÉPARÉE PAR L'UTILISATEUR, VEUILLEZ CONFIER TOUTE RÉPARATION À UN PERSONNEL QUALIFIÉ.

FCC Compliance Statement:

This device complies with Part 15 of the FCC Rules. Operation is subject to the following two conditions: (1) this device may not cause harmful interference, and (2) this device must accept any interference received; including interference that may cause undesired operation.



IMPORTANT NOTICE: DO NOT MODIFY THIS UNIT!

This product, when installed as indicated in the instructions contained in this manual, meets FCC requirements. Modifications not expressly approved by Luminex Lighting Control Equipment nv may void your authority, granted by the FCC, to use the product.

This Equipment has been tested and found to comply with the limits for a Class A digital device, pursuant to Part 15 of the FCC rules. These limits are designed to provide reasonable protection against harmful interference when the equipment is operated in a commercial environment.

This equipment generates, uses and can radiate radio frequency energy and, if not installed and used in accordance with the instructions, may cause harmful interference to radio communications. Operation of this equipment in a residential area is likely to cause harmful interference in which case the user will be required to correct the interference at his own expense.

Industry Canada compliance statement

This Class A digital apparatus complies with Canadian ICES-003. Cet appareil numérique de la classe A est conforme à la norme NMB-003 du Canada.

European Community Compliance Statement

This is a class A product. In a domestic environment, this product may cause radio interference in which case the user may be required to take adequate measures.

**Disposal of Waste Equipment by users in the European Union
Information for Users on Collection and Disposal of Old Equipment.**

This symbol on the products, packaging, and/or accompanying documents means that used electrical and electronic products should not be mixed with general household waste.

For proper treatment, recovery, and recycling of old products, please take them to applicable collection points, in accordance with your national legislation and the Directives 2002/96/EC. By disposing of these products correctly, you will help to save valuable resources and prevent any potential negative effects on human health and the environment which could otherwise arise from inappropriate waste handling. For more information about collection and recycling of old products, please contact your local municipality, your waste disposal service, or the point of sale where you purchased the items.

[For business users in the European Union]

If you wish to discard electrical and electronic equipment, please contact your dealer or supplier for further information.

[Information on Disposal in other Countries outside the European Union]

This symbol is only valid in the European Union. If you wish to discard these items, please contact your local authorities or dealer and ask for the correct method of disposal.

Warranty information**Limited warranty**

Unless otherwise stated, your product is covered by a two (2) years parts and labour limited warranty. It is the owner's responsibility to furnish receipts or invoices for verification of purchase, date, and dealer or distributor. If purchase date cannot be provided, date of manufacture will be used to determine warranty period.

Returning under warranty

Any product unit or parts returned to Luminex LCE must be packaged in a suitable manner to ensure the protection of such product unit or parts, and such package shall be clearly and prominently marked to indicate that the package contains returned product units or parts.

Accompany all returned product units or parts with a written explanation of the alleged problem or malfunction.

Freight

All shipping will be paid by the purchaser. Items under warranty shall have return shipping paid by the manufacturer only in the European Union. Under no circumstances will freight collect shipments be accepted.

Prepaid shipping does not include rush expediting such as air freight. Air freight can be sent customer collect in the European Union. Warranty is void if the product is misused, damaged, modified in any way, or for unauthorized repairs or parts.

Table of Contents

- GENERAL INFORMATION 2**
- WARRANTY INFORMATION 3**
- 1. APPLICATIONS 6**
- 2. INSTALLATION 7**
 - 2.1 Mounting the device 7
 - Rack mount 7
 - 2.2 Power up the device 8
 - 2.3 Connection to the network. 8
 - 2.4 LED indicators. 9
 - 2.5 Connection to the web interface. 9
 - 2.6 Reset 10
 - Reset via the LCD display: 10
 - Reset via LumiNet Monitor: 10
 - Reset via Araneo: 10
- 3. CONFIGURATION 11**
 - Web interface Presentation 11
 - 3.1 Node Page 11
 - How to reset a process engine 12
 - How to configure a process engine 12
 - How to copy a process engine 13
 - 3.2 DMX/RDM page 13
 - Port Settings 13
 - DMX Settings 14
 - DMX redundancy 14
 - 3.3 Play page 15
 - Show 15
 - Record Trigger 15
 - 3.4 Global Settings 16
 - Control source 16
 - Device settings 16
 - Device info 16
 - Contact closure 16
 - Miscellaneous 17

3.5	Network	18
	Scenario 1(A): (default)	18
	Scenario 2(B): (advanced)	18
	Group/VLAN advanced settings	20
	Add or Edit a Trunk	20
3.6	Toolbox page	21
	Profile manager	21
	Firmware	21
	Reset	22
4.	LCD DISPLAY	23
5.	WEB API	27
6.	LUMINODE IN DETAIL	28
6.1	What is a process engine?	28
	input	29
	Output	32
	Mode Definition	33
	patch option	36
	Patch Import/Export	36
	Master/Limit option	36
	master/limit explained:	37
	startup buffer:	37
7.	TECHNICAL SUPPORT	38
8.	CREDITS	39
9.	TECHNICAL SPECIFICATIONS	40
	Disclaimer	42

1. Applications

A few examples of applications where the LumiNode12 can be used:

- Touring & Live events
- Studio's
- Cruise ships/Yachts
- Theatres
- Arena/Stadium lighting
- Architainment lighting
- Theme parks
- Campuses
- Houses of Worship
-

Typical Applications:

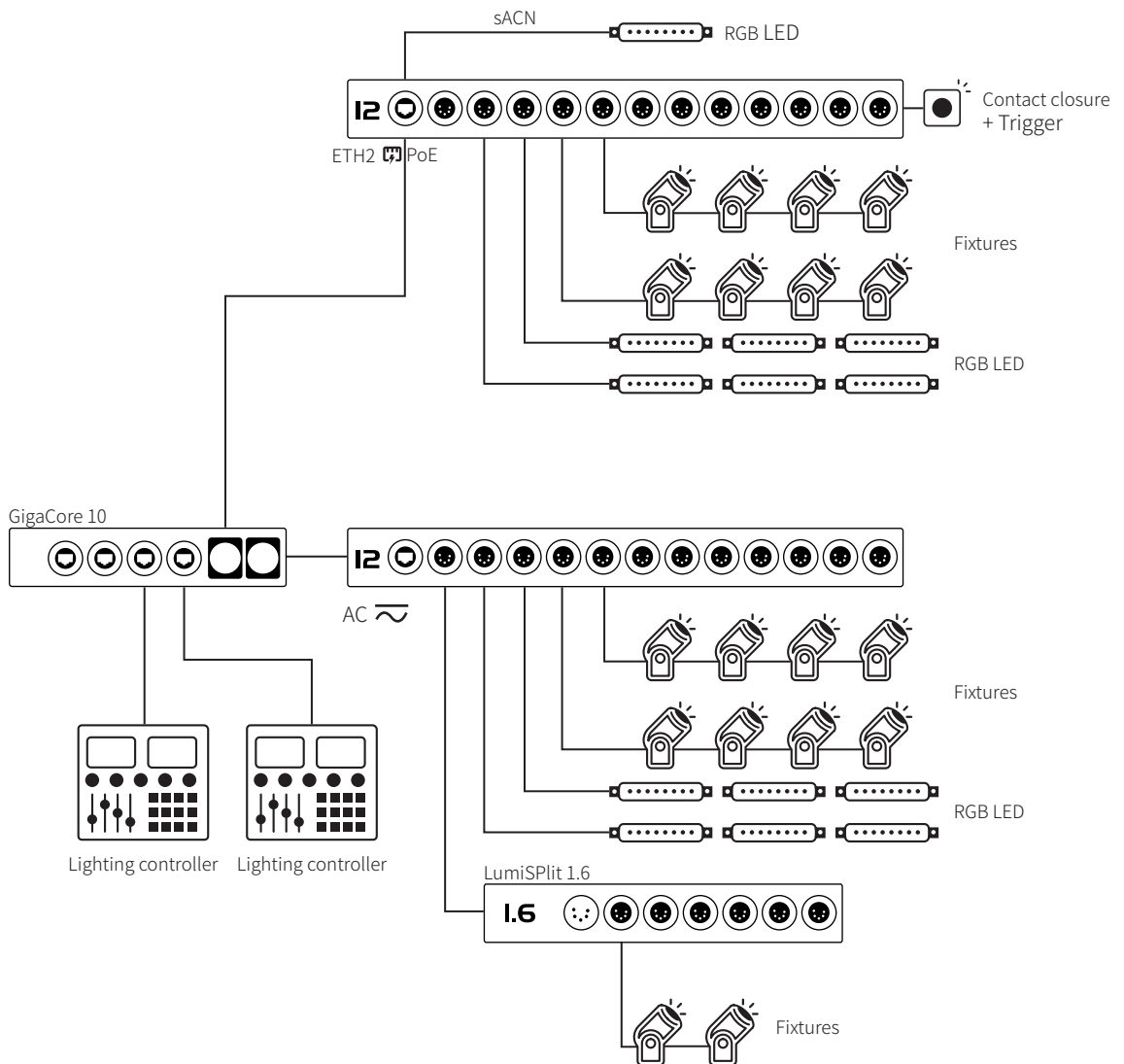

2. Installation

2.1 Mounting the device

LumiNode 12 is a device that can be rack mounted. Please read the following instructions to make sure the device is mounted and secured correctly.

RACK MOUNT

In case you want to mount your LumiNode 12 in a standard 19-inch rack, you need 4 rack screws to mount the device.

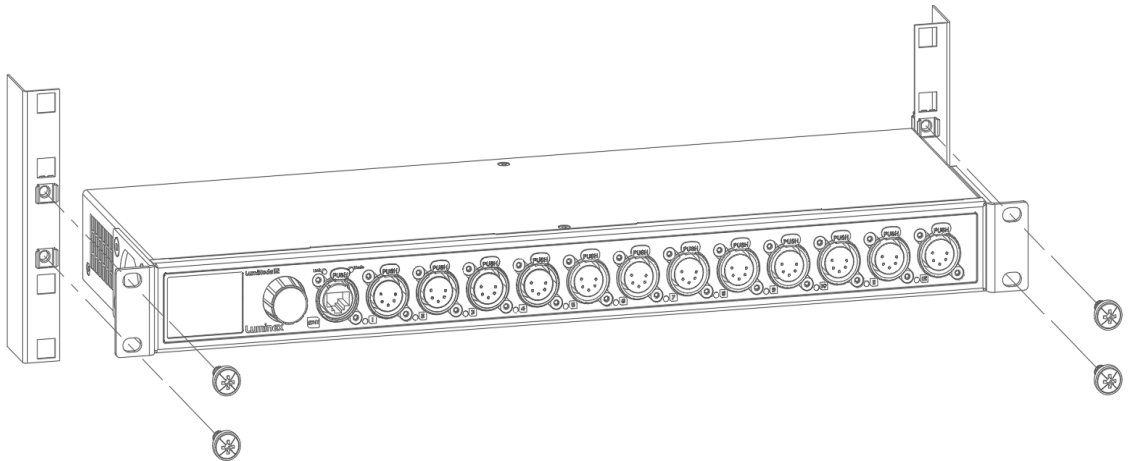

2.2 Power up the device

The LumiNode 12 can be powered with a power cable fitted with a Neutrik powerCON TRUE1 connector (M) (please contact your local dealer if you do not have a suitable power cable at hand). The device will automatically switch on. To shut it down after use, just un-plug the power cable again. The LumiNode 12 can also be powered with PoE (N).

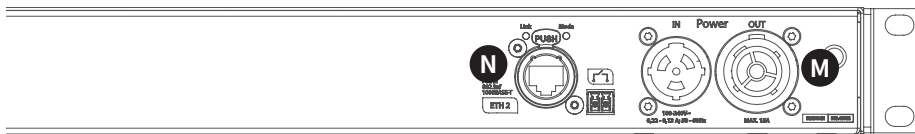

The LumiNode 12 requires standard AC power distribution from 100-240VAC, 50/60Hz. The mating Neutrik powerCON TRUE1 connector is supplied; however, you will need to purchase or construct a cable appropriate for your application. When installing a new connector please refer to the following wire colour code reference:

Wire*	Connection
Green/Yellow	AC Ground
Blue	AC Neutral
Brown	AC Line

* International (Harmonised) Standard

Alternatively, the LumiNode series are 802.3af compliant (PoE), so that each LumiNode will act as a PD (Powered Device) and can be powered by any compliant PSE (Power Sourcing Equipment) such as Ethernet switch, midspan and PoE injector. All models can only be powered with PoE via ETH2!

If both AC power and PoE are used the AC power supply will be prioritised, but the PoE will seamlessly take over if the AC power fails.

The LumiNode 12 offers the option to daisy chain up to 30 devices via the PowerCON TRUE1 outlet on the rear of the unit.

2.3 Connection to the network

To get the LumiNode 12 online in your system, connect either port ETH1 or ETH2 to a computer, or to a port of an Ethernet switch.

Only port ETH2 on the rear of the unit can be used to power the unit through PoE. Check the port labelling for a better identification.

2.4 LED indicators

There are various LEDs on the LumiNode 12. Here is a list of the LEDs, the possible colours, and the meaning of each colour:

DMX PORT	STATUS	MEANING
DMX Input	Green	Input idle
	Green flashing	Input active
DMX only (output mode)	Cyan	Output idle
	Cyan flashing	DMX activity
DMX + RDM (output mode)	Blue	Output idle
	Blue flashing	DMX activity
Stream loss	Red	Source stream lost
	Red flashing	Source stream lost but still outputting the last received packets
	Orange flashing	Source stream recovered
DMX redundancy	Magenta	Output idle
	Magenta flashing	Output active
NETWORK PORT		
Left LED (Link)	Green	Gigabit connection (flashing: Ethernet traffic)
	Orange	100Mbit connection (flashing: Ethernet traffic)
Right LED (Mode)	Blue	Default colour
	Green flashing	Device booting
	Orange flashing	Firmware upgrade in progress
	Green blinking	Identify in progress
	Group colour	Corresponding to assigned group/VLAN

2.5 Connection to the web interface

- The LumiNode 12 IP address can be found at the rear of the unit or on the LCD display.
- Set your computer with a compliant IP address (do not use the same IP address!).
- Connect your computer to the LumiNode with a network cable.
- Launch your favourite web browser.
- Type the IP address of the LumiNode in the address field followed by enter.

2.6 Reset

RESET VIA THE LCD DISPLAY:

When the device is powered up, by default the LCD display shows the status screen with the status of the 4 XLR ports. To reset the device please follow the following steps:

- Press the jog wheel once to enter the main menu.
- Scroll down until you see Toolbox.
- Press the jog wheel once to enter the toolbox.
- Scroll down until you see Reset.
- Press the jog wheel once to enter the reset menu.
- A pop-up window opens giving you the option to Preserve IP settings and Preserve user profiles.
- Choose which option you want by using the jog wheel to scroll between the two options and press the jog wheel to confirm.
- At the bottom of the pop-up window, you have the option to Reset or Cancel.
- If you choose cancel you get a message that the reset has been cancelled.
- If you choose reset, you get a new screen asking to confirm the reset command. Once 'Yes' is selected the LumiNode will reset.

RESET VIA LUMINET MONITOR:

LumiNet Monitor is available for Windows and MacOS and can be found in the download section of our website: <http://www.luminex.be/support-2/product-downloads/>

How to reset your LumiNode through LumiNet Monitor:

- With a computer connected to the device, open LumiNet Monitor (version 2.3.3 or above).
- Under Tools in the menu bar you find Reset LumiNode.
- Enter the MAC address of the device you want to reset. This can be found on the label with the IP address or via the web-UI.
- Choose if you want to keep the IP settings.
- Choose if you want to keep the profiles.
- Click reset.

RESET VIA ARANEO:

Araneo is available for Windows and MacOS and can be found in the download section of our website: <https://www.luminex.be/download-araneo/>

How to reset your LumiNode through Araneo:

- With a computer connected to the device, open Araneo (version 1.4.0 or above).
- Select the LumiNode you wish to reset.
- The Reset option becomes available on the Utilities section of the system tray at the bottom of your screen in Araneo:
- Choose if you want to keep the IP settings.
- Choose if you want to keep the profiles.
- Click reset.

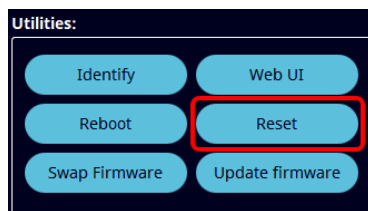

3. Configuration

WEB INTERFACE PRESENTATION

Launch your favourite web browser and type the IP address of your LumiNode. Press **enter** to validate.



3.1 Node Page

- (A) **Identify:** Clicking on the Luminox logo will identify your LumiNode in the network. The LCD display will turn green and the Mode LED will flash green for 5 seconds. In the web-UI you get the text “Identified” under the logo and the LCD area will change colour.
- (B) **Drawing of your LumiNode:** This product image shows the configuration of each DMX port. The centre icon within each DMX port represents an input or an output. On the top of each port, you can see the mode of the process engine linked to that port.
- (C) **Navigation menu**
- (D) **Input:** According to the mode set on the process engine, the input block will display all relevant information, such as the type of incoming protocol, the universe number, the source IP address, or the DMX input port.
- (E) **Process engine:** By default, the LumiNode comes with Forward mode activated on as many process engines as DMX port(s). The block displays the mode currently set on the process engine. For ease of identification, you can change the name of the process engine. On the left and on the right-hand side of the process engine, are respectively the patch, master/limiter and startup buffer icons. The colour of the icon will change if any parameters of these menus are modified. For more details about the process engines and how to configure them please see chapter 6 of this manual.
- (F) **Output:** The output block will display all relevant information, such as the type of outgoing protocol, the universe number, the destination IP address, or the DMX output port.
- (G) **Increment/Decrement:** Use these shortcuts to quickly increase or decrease the value of a universe. Select the process engine first, after which the increment/decrement tool becomes available.
- (H) **Reset tool and padlock:** Use this tool to reset one or several process engines. First select the process engine(s) by clicking on the top left corner of the input block followed by the trashcan icon. The padlock allows you to lock the LumiNode configuration page to prevent unsolicited action on the web page. This is an ideal tool for show time.
- (I) **Clear Warnings:** Clear all stream loss indications.
- (J) **Active Profile:** In this area the current active profile of the LumiNode is being displayed.
- (K) **Theme and language:** Select here if you want to use the dark theme or light theme. Interface supported languages are English, Japanese and Chinese for now.
- (L) **Help:** In case you need help, here you find an onboard helpfile.

HOW TO RESET A PROCESS ENGINE

To reset a process engine, follow the following steps:

- Hover your mouse over the top left corner of the process engine and select the tick box.
- Click on the trash can icon at the top right corner above the first process engine.

A blank process engine appears as follows:



If you want to reset all the process engines at once, navigate to the top left above the first process engine and select the tick box “Select all Process Engines”

HOW TO CONFIGURE A PROCESS ENGINE

To configure a process engine, first click on the SELECT MODE label (the centre block of the process engine), the process engine panel appears.

Click on the icon to select the mode you wish to use. Modes are described in chapter 5 of this manual.

- **Forward**, an input is send to an output.
- **LTP merge**, Latest Takes Precedence with up to four inputs.
- **HTP merge**, Highest Takes Precedence with up to four inputs.
- **Backup**, Input 2 becomes active if input 1 is not available.
- **X-Fade**, Cross-fade between input 1 and input 2.
- **Switch**, with the use of a control source choose which of the up to four inputs is active.
- **Custom**, any of the other modes, or combination of, on a channel level.

At any time, you can click on the Patch button , the Master/Limit button , or the Startup Buffer button to open the relevant configuration panel.

Next, click on the left-hand block, to select your input . According to the selected mode, the number of inputs may vary. A process engine supports up to four inputs.

Input options are:

- **DMX**, physical input on the XLRs.
- **Art-Net**: Select the Art-Net universe to use. You can enter a numeric value between 0 and 32767.
- **sACN**: Select the sACN universe to use. You can enter a numeric value between 1 and 63999.
- **KiNET**: KiNETv2, the port number is automatically matched to the number of the process engine.
- **RTTrPL**, BlackTrax: Select the RTTrPL universe to use. You can enter a numeric value between 0 and 63999.
- **Internal**, the result of another process engine.
- **Play**, one of the recorded shows.

You can give your input a name for easy identification.

Next, select your output by clicking on the output block, located on the right-hand side.

Here, you can choose between DMX, Art-Net, sACN, KiNET or any combination of the four to send data coming from the process engine. The four types of output can be used at the same time, providing you with great flexibility.

Once selected, click on the Save button to store the parameters of your process engine. Your engine is ready to go!

HOW TO COPY A PROCESS ENGINE

Once you have created your first process engine, select it by clicking on the tick box in the top left corner. A handle appears at the bottom centre of the process engine.

Click and drag the handle down, to select other process engines.

The LumiNode will automatically increase the universe number, and the DMX port, for each following process engine. This allows you to create a complete configuration in a snap!

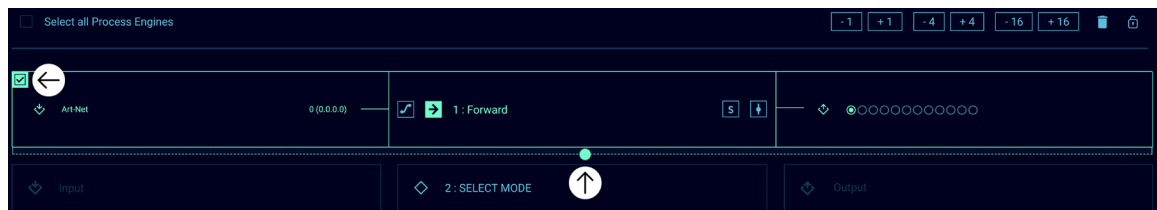

3.2 DMX/RDM page

The DMX/RDM page is divided in two sub menus:

PORT SETTINGS

The port settings offer you to:

- Add a legend to a port to easily identify what is connected to it. This will also update the tooltip on the configuration page of the process engine.
- Enable Sync mode: when enabled the DMX output framerate is matched to the input framerate. If the source used for this port is capable to send an Art-Net or sACN sync packet this will be used.
- Redundant Slave: when enabled the DMX port listens to incoming DMX from another port or another node and will start outputting if no DMX input is detected. When DMX redundant slave is enabled RDM is automatically disabled. See the chapter about DMX redundancy further on in the manual.
- Enable RDM, enabling RDM allows RDM traffic to be transported to or from an outlet over the network and back.
 - Adaptive discovery. When RDM is enabled, it is possible to enable adaptive discovery. This will continuously check for new and disappeared RDM devices on the output.
 - Interweaving. Interweaving is enabled by default. Interweaving is only available when the FPS is set lower or equal to 34 FPS. Interweaving makes that RDM messages are interweaved with DMX. If your fixture does not support interweaving or the RDM packets you are sending are too large you would disable RDM interweaving. For example, with a RDM based follow-spot system interweaving needs to be disabled.
 - ArtRDM universe. The ArtRDM universe is the universe which is used for ArtTOD and ArtRDM packets. By default, this will be matched to the Art-Net universe of the first Art-Net input of your process engine.

Scroll down and click **Save** to save your settings.

At the bottom of the DMX/RDM page, you can find a button to force an RDM discovery in case this is required.

DMX SETTINGS

On the DMX/RDM page, at the bottom of the page, you find the DMX settings.

- DMX Framerate in Frames Per Second.
- Breaktime in microseconds.
- DMX output time continuous by default is enabled and the LumiNode will keep outputting the last received stream packages on the DMX. When you disable the continuous output time you can choose a time the LumiNode will keep outputting the data with a minimum time of 1 second.
- RDM Controller IP is the only device in the network that can make changes via RDM. When 0.0.0.0 every device in the network can make changes but if you want to have a dedicated device to manage the RDM you can define the IP here.

Press **Save** to apply your settings.

DMX REDUNDANCY

The LumiNode range supports DMX redundancy from firmware 2.1.0 onwards. What does DMX redundancy mean and how does it work?

DMX redundancy means that you can run a DMX cable from one LumiNode to your lights and then from the output of the last light back to the same LumiNode or to a different LumiNode.

(If the redundant port is on the same LumiNode, only one process engine is required to configure both ports).



The redundant port will not output DMX until it is no longer receiving DMX.

Once a link in the DMX chain gets broken or disconnected the slave port will start outputting DMX and the lights will continue to operate as expected.



As soon as the broken link is restored the redundant port will go back to an idle state.

NOTE: For this system to work between different LumiNodes, it is important that the configuration of both process engines and the settings for sync and DMX framerate are identical!

When the redundant port is in idle state, the port LED is solid magenta and the LCD display on the LumiNode 4 will show the outline of the output symbol in magenta.

As soon as the port becomes active the port LED will turn to flashing magenta and the LCD display will show a magenta filled output symbol.

Redundant port IDLE:

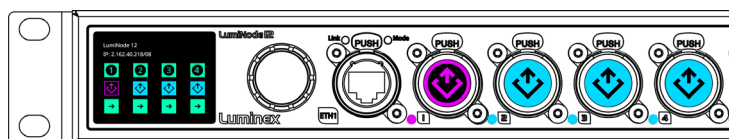

Redundant port ACTIVE:

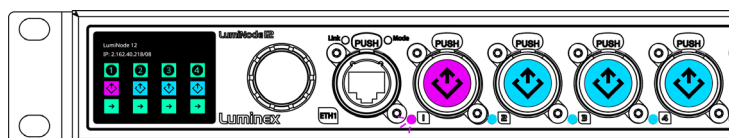

3.3 Play page

The play page is divided in two sub menus:

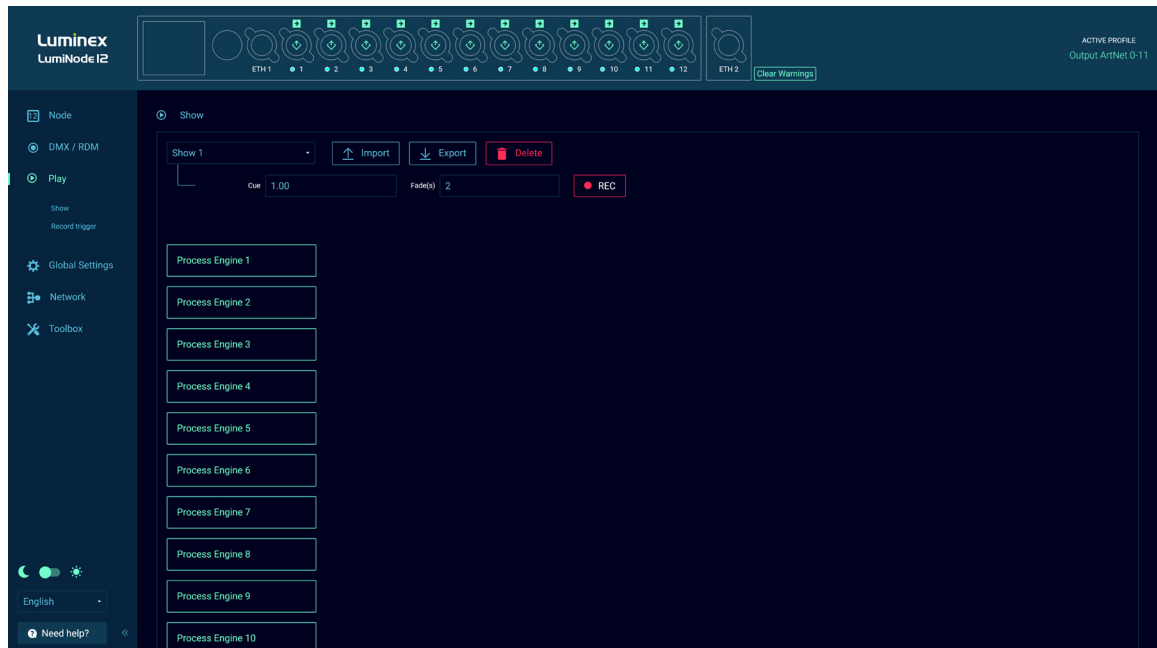

SHOW

Here you select in which show you want to record cues, which cue number and the fade time in seconds. Other options here are:

- **Import** a show that you have available offline.
- **Export** the show you have selected to your computer.
- **Delete** the selected show.
- **Cue** is the cue number that will be stored next.
- **Fade(s)** is the fade time in seconds assigned to the cue when recorded in the web interface.
- **Rec** records a new cue. Each cue is a snapshot of the output of all process engines.

RECORD TRIGGER

When you scroll down on the play page you will find the Record Trigger settings.

Here you can set the record channel, this is the channel you will be sending from your control device, the control source protocol and universe. This can also be assigned to a specific source IP address if required.

The following options with corresponding values are available for the record trigger:

- 101 - record next cue in show 1
- 102 - record next cue in show 2
- 103 - record next cue in show 3
-
-
- 139 - record next cue in show 39
- 140 - record next cue in show 40

3.4 Global Settings

The global settings page is divided in five sub menus:

CONTROL SOURCE

Here, you can set the type of protocol, the universe number, and the controller IP address for each control source. If the IP address 0.0.0.0 is used all devices in the network generating the assigned control protocol and universe can be the control source. The LumiNode will use an LTP merging policy between the first four sources that become available. When using sACN the priority is also important to consider.

Each control source can be a different protocol, universe, and controller IP.

Press **Save** to apply your settings.

DEVICE SETTINGS

In this menu, you can set:

- Short name. Enter a name of maximum 17 characters to indicate the node on Art-Net. The following characters cannot be used: ^[-~]*\$.
- Long name. Enter a name of maximum 63 characters to indicate the node on Art-Net. The following characters cannot be used: ^[-~]*\$.
- ID number of the LumiNode. The ID number is used for indication only.

Press **Save** to apply your settings.

DEVICE INFO

The device info window shows the MAC address and serial number of your device.

CONTACT CLOSURE

In this menu you can setup the details for the contact closure.

Protocol can be Art-Net or sACN.

Universe is the universe created by the contact closure.

Destination IP/Priority allows you to broadcast or unicast the contact closure's universe when using Art-Net. If no IP is entered the broadcast address will be auto filled. When sACN is chosen as protocol this becomes the priority.

Channel is the control channel created by the contact closure.

Open is the value (0-255) of the control channel when the contact is open.

Closed is the value (0-255) of the control channel when the contact is closed.

Press **Save** to apply your settings.

The following values are linked to the options Switch, Play and Backup: (these can be found under the question mark symbol on the Global Settings page/Contact Closure)

- General
 - Do Nothing: 0 - 7
- Switch
 - 8 - 15: Input 1
 - 16 - 23: Input 2

- 24 - 31: Input 3
- 32 - 39: Input 4
- Play
 - 8 - 15: Go
 - 16 - 23: Forward
 - 24 - 31: Back
 - 32 - 39: Reset
 - 101 - 140: Record
- Backup
 - 8 - 15: Recovery



MISCELLANEOUS

LCD auto-off (sec) allows you to set the LumiNode to automatically switch off the LCD after the set time. By default, this is set to 600 seconds. If the value is set to zero, the display will always stay ON.

LCD pin allows you to set a PIN to lock changing settings via the LCD screen. Click on the slider to enable the LCD pin.

Web auth, for security reasons, a password can be enabled on the LumiNode's web interface. Click on the slider to enable web authentication, and type in your password.

Led slider allows you to change the brightness of the LEDs on the LumiNode.

Press **Save** to apply your settings.

3.5 Network

The network page is divided in two scenarios.

SCENARIO 1(A): (DEFAULT)

The Lighting data input/output and the management of the LumiNode are all assigned to the same network group and share a single IP address.



In the IP address section (C):

- Enter the IP address you wish to use.
- Enter the subnet.
- Enter a gateway IP address if required.
- Click **Save (J)** to apply the changes.
- Enter the new IP address in your web browser to refresh the page.

SCENARIO 2(B): (ADVANCED)

Groups/VLANs including an ISL group (Trunk) can be assigned to ports and interfaces.

This can be useful when data from different applications, in coexistence with the lighting data, needs to be transported over the same network.

The Lighting data input/output and the management of the LumiNode can be separated in different network groups and can each have a unique IP address.

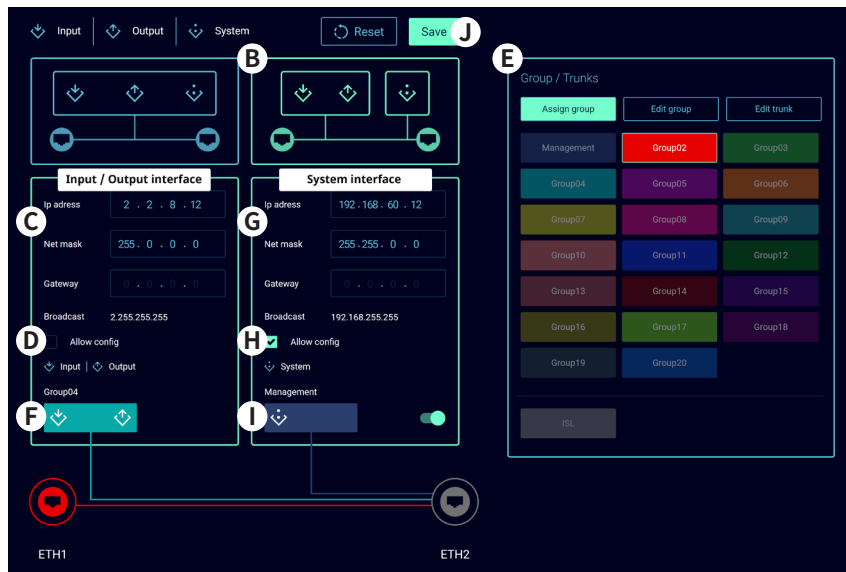

In the Input/Output interface:

- Enter the IP address you wish to use (C).
- Enter the subnet you wish to use.
- Enter a gateway IP address if required.
- Enable/Disable Allow config (D). When disabled, users will not be able to reach the web-UI on this IP address.
- In the Group/Trunks window (E) select the group for the lighting data you wish to use.
- With the group selected, click the group assignment on the input/output interface (F).

In the System interface:

- At the bottom-right of the System interface, use the slider to enable the interface.
- Enter the IP address you wish to use (G).
- Enter the subnet you wish to use.
- Enter a gateway IP address if required.
- Enable/Disable Allow config (H). When disabled, users will not be able to reach the web-UI on this IP address.
- In the Group/Trunks window (E) select the group for the system interface you wish to use.
- With the group selected, click the group assignment on the system interface (I).

Network ports:

Depending on the configuration chosen for the interfaces we now need to assign the correct groups/trunks to the Ethernet ports of the LumiNode.

- Select the group or trunk you wish to assign in the Group/Trunks window (E).
- With the group selected, click the Ethernet port you wish to assign this group to.
- Repeat these steps for the second Ethernet port if required.

In the image above, the example shows that we have assigned an ISL to ETH2, we used the management group for the system interface, and we used group 4 for the input/output interface. Finally, we assigned group 2 to ETH1 to give the user access to this group on the front of the LumiNode.

When all the settings are done, click **Save (J)** to apply the configuration.

Enter the new IP address in your web browser to refresh the page.

GROUP/VLAN ADVANCED SETTINGS

To change the settings for a group, click on the Edit group option in the Group/Trunks section.

With a group selected you can:

- Change the VLAN ID.
- Change the name for ease of identification.

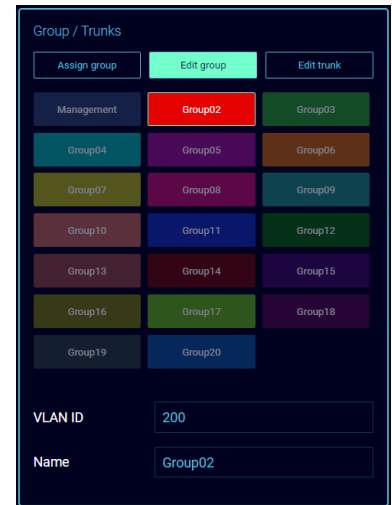

ADD OR EDIT A TRUNK

To Add or Edit a Trunk, click the Edit Trunk option in the top right of the Group/Trunks section.

To Add a custom Trunk:

- Click the + to add a trunk.
- Give the new trunk a name in the name field.
- Assign a colour to the trunk by clicking on the coloured square. After selecting the colour, click anywhere outside the colour picker window to close it.
- Click on all the groups/VLANs you wish to include in this trunk.
- If needed, use the dropdown menu for Untagged to select which group should be untagged on the trunk. An untagged port connects to hosts. The host is unaware of any VLAN configuration.

Your custom trunk is now available in the Assign group tab to be assigned to ETH1 or ETH2.

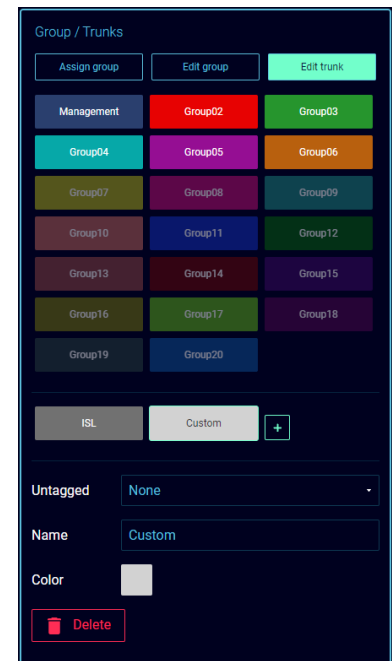

3.6 Toolbox page

The toolbox page is divided in three sub menus:

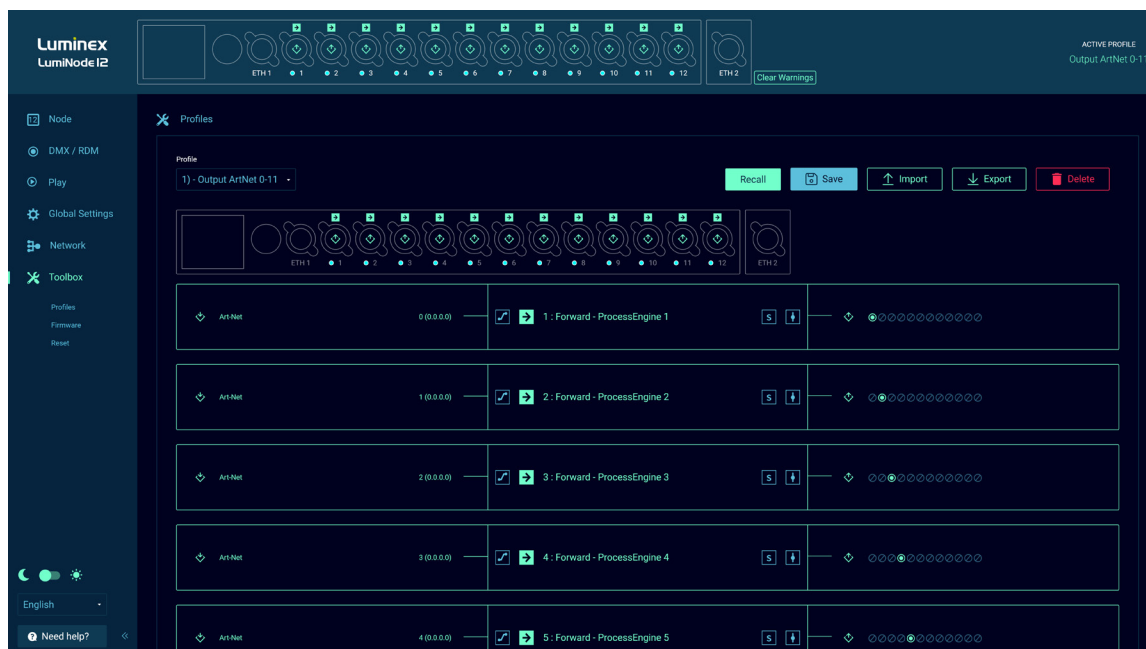

PROFILE MANAGER

Here, you can recall, save, import, export or delete a profile. Select the profile with the drop-down menu located on the left hand-side. The LumiNode comes with default profiles that can be used or modified, for a fast setup time. Up to 40 profiles can be stored in a unit.

Once a profile is selected, a preview of the configuration is shown below the dropdown in graphic form and the configuration of each process engine.

When a profile has been selected the user can scroll down to the bottom of the profile preview to see the IP settings in this profile. By default, the LumiNode will NOT load the IP settings that are stored in the profile. If you want to load the IP settings saved in the profile, slide the Preserve IP settings to OFF.

FIRMWARE

In the firmware section, you can see two versions of firmware:

- Active firmware is the one currently running on the unit.
- Alternate firmware is the previously installed firmware.

If you would like to downgrade the unit to the previously installed firmware, click on the Activate button. The unit will reboot in this firmware.

There is only ONE firmware version for the entire range. This can be installed on all different models in the range.

You can upgrade the LumiNode with our latest firmware. To upgrade the unit, please apply the following procedure:

- Download the latest firmware from the support section of our web site, <https://www.luminex.be/support-2/product-downloads/>
- Extract the downloaded archive and have a look at the release notes included.
- Click on the firmware upgrade button in the web-UI of your device.

- Select the file you have extracted.
- The LumiNode will start the firmware upgrade. The unit will reboot after the upgrade is completed.

RESET

In this panel, you can reset the LumiNode, with two separate options:

- Preserve IP address, all settings get restored to factory default apart from the IP address set to reach the device. Custom profiles are all deleted and modified default profiles are restored to default.
- Preserve profiles, during the reset the custom stored profiles and modified default profiles are being kept.

Click on the Reset button to perform the selected reset.

Performing a reset with these two options disabled will bring the LumiNode to its factory settings.

4. LCD Display

From firmware version 2.0 onwards the LCD display has been activated and the following information can be found on the display.

In normal operation the LumiNode will step through the port overview pages depending on the total amount of ports on the model. If more than 4 ports are available, the display will change every 5 seconds.

The following image is showing the layout of the display:

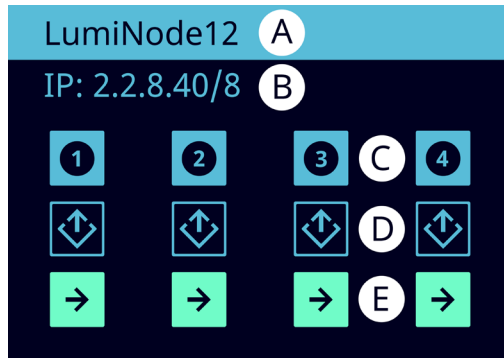

- (A) Short name of the device (default is the model of the device).
- (B) IP address/Netmask (/8 = 255.0.0.0, /16=255.255.0.0, /24=255.255.255.0). If advanced networking is configured, the LCD display will not be showing the IP configuration.
- (C) Port number.
- (D) Shows if the port is an input or an output.
- (E) Shows the mode of the process engine.

For a more detailed view per port, you can use the jog wheel and scroll to the right.

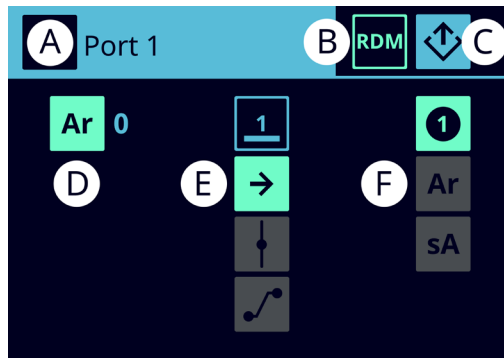

Example of detailed port info:

- (A) Port number you are viewing.
- (B) When the RDM icon is showing, RDM is enabled on this port.
- (C) Shows if the port is an input or an output.
- (D) Shows the input of the process engine, what protocol and which universe.
- (E) Displays which process engine is linked, what mode the process engine is in, if there is a patch or if the master/limit has been set.
- (F) Shows the output of the process engine, universe number and protocol.

To quickly assign a universe to a port, scroll to the port number and click the jog wheel.

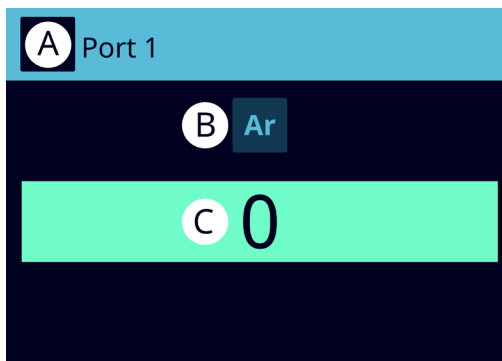

- (A) Port number you are viewing.
- (B) Protocol that is configured for this port.
- (C) Current universe assigned to this port. Use the jog wheel to change the universe number and press to confirm. A popup window will appear asking you to confirm the changes.

If a source stream fails on a port the LCD display will show this by changing the Output red. 

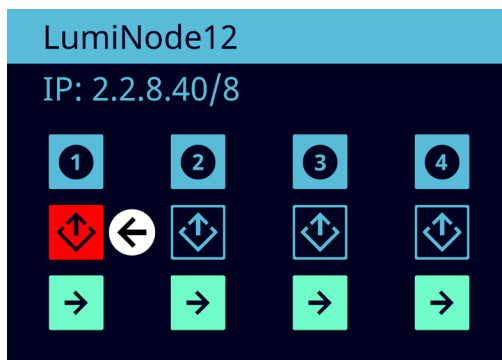

If the lost stream is recovered the LCD display will show this by changing the Output orange.  This way the user can see the source stream has been lost but has been restored.

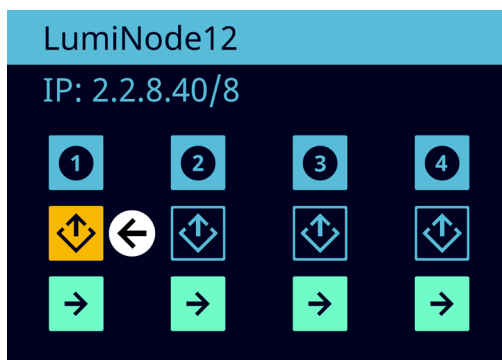

To clear warnings, scroll to the following display and press the jog wheel. This screen can be found when scrolling left once when ports 1-4 are shown or to scroll all the way to past the last detailed port info.

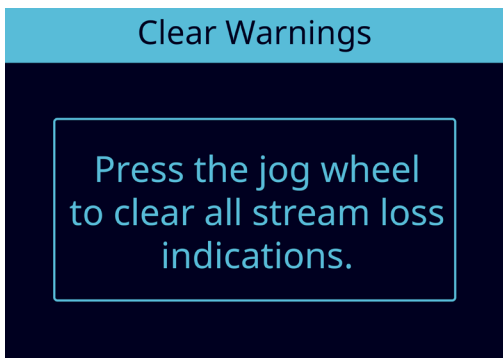

If the advanced network has been configured and the user is accessing the network setting via the display, the following popup will appear to warn the user.

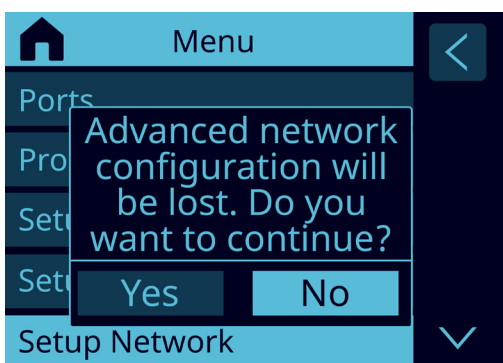

If the port is in DMX redundant mode and idle the output icon has a magenta outline: 

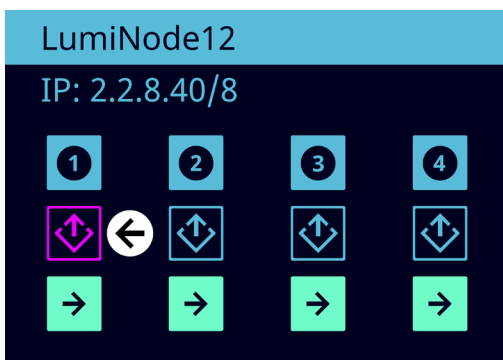

If the port is in DMX redundant mode and active the output icon is solid magenta: 

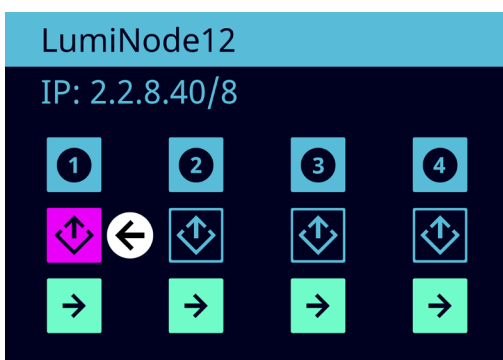

Menu tree view:

Home

- Ports
 - Status overview of the ports
- Process Engines
 - Status overview of the process engines
- Setup Port
- DMX / RDM Setup
 - Sync
- Redundant Slave (Not available if RDM is enabled)
 - RDM Enabled
 - Adoptive discovery ON/OFF
 - Interweaving ON/OFF
 - Fast Engine Setup
- Setup Process Engine
 - Configuration of process engines
- Setup Network
 - IP
 - Subnet
 - Gateway
 - Mac address
- Profile Manager
 - Save
 - Recall
- Device Info
 - Toolbox
 - Display Off
 - Reboot
 - Reset
 - RDM Discovery
 - Display Setting
 - Dark / Light
 - Display Off
 - Language
 - Enable / disable screensaver
 - Enable / disable auto rotate status page

5. Web API

The LumiNode range supports the use of Web API.

For a detailed list of available actions via Web API, please type the following in your favourite web browser:

`http://IP_OF_YOUR_DEVICE/api/doc`

6. LumiNode in detail

The LumiNode series is a new range of network converter, inheriting more than a decade of experience from the Luminex Ethernet-DMX converter design and manufacturing.

In the past, most of the people were designing their system according to the number of universes and DMX ports they would need on their lighting control system.

But today, with the ever-increasing number of lighting-controlled devices fitted with an Ethernet port, there is a need for more processing power and data handling flexibility. This is where the LumiNode series steps in.

Instead of assigning universes to a port, the user can now select any incoming data, handle it the way they need, and send it back to the network, or to a DMX port. All the data handling will be powered by process engines.

6.1 What is a process engine?

A process engine is an entity within the LumiNode firmware, accepting up to four inputs, and which can send it to up to four different outputs. Additionally, remote interaction and control can be applied to the process engine, via specific control channels.

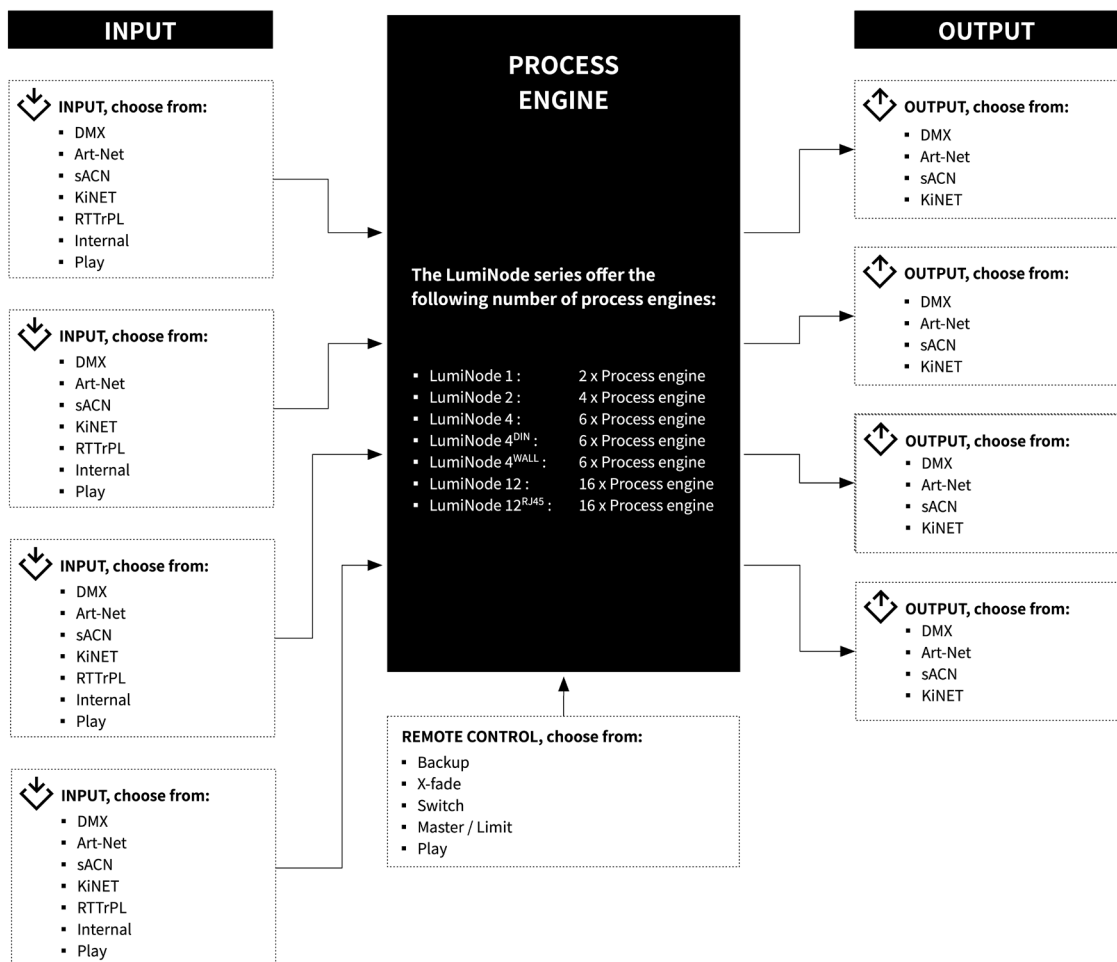

INPUT

A process engine supports the following inputs:

DMX:

A DMX source, such as a lighting control desk, can be connected to any of the DMX port(s) of the LumiNode. You will need to use a male to male adaptor to connect the console to the DMX port of the LumiNode. In the input configuration, you click on the port you wish to use as an input port, to enable the DMX input. A greyed-out port with a diagonal bar in it means this port is already used.

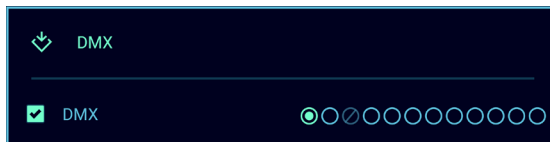

Art-Net:

Any Art-Net controller can be used as an input for the process engine. The LumiNode supports all Art-Net revisions, including Art-Net IV.

Tick the box to select Art-Net as an input protocol.

Here you can add the universe number you wish to use, and you can specify the IP address of the source. If you leave the source IP field 0.0.0.0 any source in the network outputting this universe will be used. The LumiNode process engine will bind this input to the first source using this universe number.

For a better identification of the source, you can add a text to your Art-Net input.

Advanced settings:

Next to the Source IP field you find a cog wheel for advanced settings:

- **Accept Own Data.** In some cases, it is required to ignore the Art-Net data generated by the LumiNode itself. When disabled the LumiNode will only listen to other sources in the network. By default, the Accept Own Data is enabled.

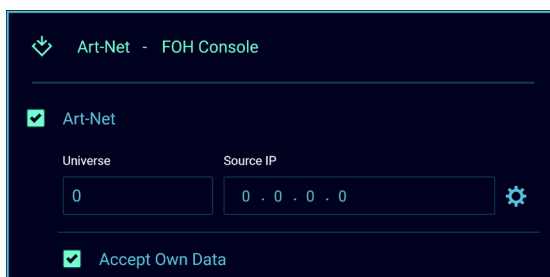

sACN:

Any sACN controller can be used as an input for the process engine.

Tick the box to select sACN as an input protocol.

Here you can add the universe number you wish to use, and you can specify the IP address of the source. If you leave the source IP field 0.0.0.0 any source in the network outputting this universe will be used. The LumiNode process engine will bind this input to the first source using this universe number.

For a better identification of the source, you can add a text to your sACN input.

Advanced settings:

Next to the Source IP field you find a cog wheel for advanced settings:

- **Per-channel Priority Mode.** To better handle multiple source control scenarios, the 0xDD sACN start code has been introduced to allow setting a source priority for each channel of a universe.

The following rules apply:

- If all sources have the same priority HTP will be applied.
 - If for a source the 0xDD packet is not available, the standard universe priority is being used.
 - The number of sources is unlimited.
-
- **Accept Own Data.** In some cases, it is required to ignore the sACN data generated by the LumiNode itself. When disabled the LumiNode will only listen to other sources in the network. By default, the Accept Own Data is enabled

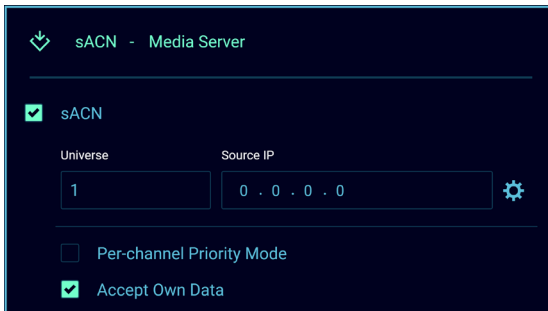

KiNET v2:

The LumiNode process engine supports KiNET v2.

Tick the box to select KiNET v2 as an input protocol. The port number is automatically matched to the number of the process engine.

Here you can specify the IP address of the source.

If you leave the source IP field 0.0.0.0 any source in the network outputting this universe will be used. The LumiNode process engine will bind this input to the first source using this universe number.

For a better identification of the source, you can add a text to your KiNET input.

Advanced settings:

Next to the Source IP field you find a cog wheel for advanced settings:

- **Accept Own Data.** In some cases, it is required to ignore the KiNET data generated by the LumiNode itself. When disabled the LumiNode will only listen to other sources in the network. By default, the Accept Own Data is enabled.

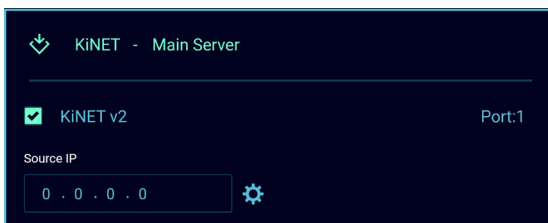

RTTrPL:

The LumiNode process engine supports Real Time Tracking Protocol for Light, by Cast Software. As an example, the LumiNode can be used to transition between a lighting console and a BlackTraX tracking system, seamlessly.

Tick the box to select RTTrPL as an input protocol.

Here you can add the universe number you wish to use, and you can specify the IP address of the source. If you leave the source IP field 0.0.0.0 any source in the network outputting this universe will be used. The LumiNode process engine will bind this input to the first source using this universe number.

For a better identification of the source, you can add a text to your RTTrPL input.

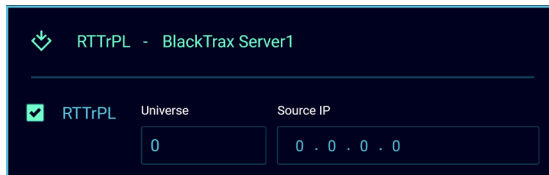
**Internal:**

This input option allows you to use the output of another process engine, this allows you to make an even more complex setup.

Use the dropdown menu to select which process engine you want to use as input.

For a better identification of the source, you can add a text to your Internal source.

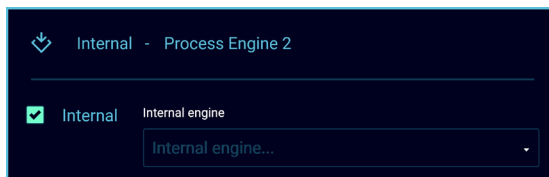
**Play:**

This input option allows you to use the recorded cues from internal shows as an input to the process engine.

First select which show you want to use, then select the process engine that you want to use. All the process engines of the LumiNode are always available to choose from.

For a better identification of the source, you can add a text to your Play source.

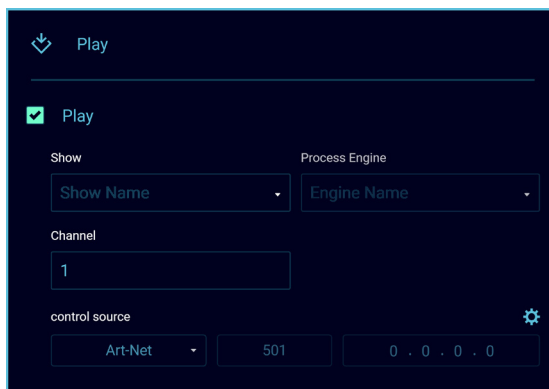

Select the control channel you want to use to control the cue list. Use the cog wheel to set the source protocol and universe and if required a specific controller IP.

Control channel options:

8 - 15: **Go**, play the next cue in the cue list.

16 - 23: **Forward**, pre-set the next cue. This allows you to trigger forward for example twice to skip a cue.

24 - 31: **Back**, pre-set the current cue again. To go to the previous cue, you need to trigger this option twice.

32 - 39: **Reset**, reset the cue list to the first cue in the list.

OUTPUT

A process engine offers the following outputs or a combination of all available options:

DMX:

One or several DMX ports can be selected to output the data transferred by the process engine. A greyed-out port with a diagonal bar means this port has already been used.

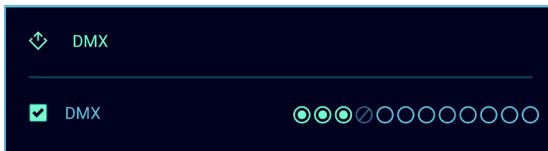

Art-Net:

All data handled by the process engine can be sent back to the network as a new or the same Art-Net universe.

Here you can set the universe number you wish to use. You can specify the IP address of the destination, by ticking the Unicast box. By default, the LumiNode will transmit this Art-Net universe to the broadcast address of the IP range the unit is part of.

For a better identification, you can add a text to your Art-Net destination.

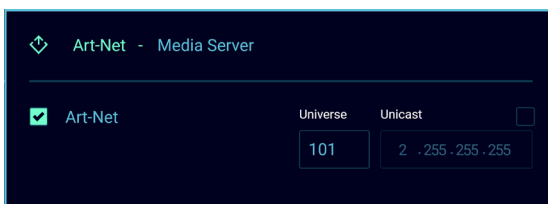

sACN:

All data handled by the process engine can be sent back to the network as a new or the same sACN universe.

Here you can set the universe number you wish to use, and you can specify the priority for this sACN universe.

For a better identification, you can add a text to your sACN destination.

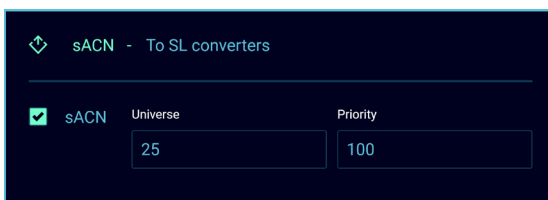

KiNET:

All data handled by the process engine can be sent back to the network as a new or the same KiNET universe.

Here you can set the version you wish to use, the universe number you wish to use (default is Don't care), the priority (default 0) and the port number you wish to send this universe to.

You can specify the IP address of the destination, by ticking the Unicast box. By default, the LumiNode will transmit this KiNET universe to the broadcast address of the IP range the unit is part of.

For a better identification, you can add a text to your KiNET destination.

**MODE DEFINITION**

The LumiNode series offer 7 different modes for each process engine:

FORWARD

In forward mode one input source is send to up to 4 outputs. You can output to a physical port on the converter, forward to another Art-Net, sACN or KiNET universe, or any combination of the four.

Patch, Master/Limit and startup buffer options are available for this mode.

LTP MERGE

Latest Takes Precedence merging policy is commonly used to merge fixture channels. Up to 4 inputs (Art-Net, sACN, KiNET, DMX, RTTrPL, Internal, Play or combination of) can be merged.

The output can be DMX, Art-Net, sACN, KiNET or any combination of the four.

Patch, Master/Limit and startup buffer options are available for this mode.

HTP MERGE

Highest Takes Precedence merging policy is commonly used to merge dimmer channels. Up to 4 inputs (Art-Net, sACN, KiNET, DMX, RTTrPL, Internal, Play or combination of) can be merged.

The output can be DMX, Art-Net, sACN, KiNET or any combination of the four.

Patch, Master/Limit and startup buffer options are available for this mode.

BACKUP

In Backup mode, two inputs will be used which can be DMX, Art-Net, sACN, KiNET, RTTrPL, Internal or Play where the first input has precedence over the second input. The output can be DMX, Art-Net, sACN, KiNET or any combination of the four.

When input 1 fails the node will switch to input 2, automatically. Auto-recover is enabled by default.

Auto Recover:

- When auto recovery is enabled the LumiNode will switch back to input one as soon as this is back available in the network. In this case the warning for the missing backup control source can be ignored.
- When auto recovery is disabled, you can configure which protocol is used to trigger the recovery, which universe and which channel. This can be narrowed down to a specific IP address which will be the only device able to control the backup recovery.



The red warning triangle is a warning that the process engine cannot be configured without a backup control source. This is to indicate that the control source has not been configured yet for remote recovery. As soon as the control source has been configured this triangle will disappear.

When the backup control option is used, the LumiNode will not restore to input one when this becomes available in the network. To recover, a value between 8-15 (0-255) needs to be send on the control channel to trigger the recovery.

Patch, Master/Limit and startup buffer options are available for this mode.

X-FADE

This mode offers to you to cross fade between two sources. Ideal in a situation where you need to cross fade between a lighting desk and a media server, the control channel allows you to keep full control on the speed and smoothness of the transition.

From the X-Fade panel, you can define the control channel, the protocol and universe number, and the IP address of the control source. Click on the gearwheel icon to change these parameters.

When the control channel is at zero, source one is in full control, when the control channel is at full, source two is in full control.

Patch, Master/Limit and startup buffer options are available for this mode.



The red warning triangle is a warning that the process engine cannot be configured without a X-Fade control source. This is to indicate that the control source has not been configured yet for the X-Fade. As soon as the control source has been configured this triangle will disappear.

Patch, Master/Limit and startup buffer options are available for this mode.

SWITCH

The switch functionality provides you with an easy to use tool to remotely select within up to four inputs, which input can control your rig. By sending different values for the switch channel, you'll be able to select the relevant input. The switching between inputs does not include any crossfade.

From the switch panel, you can define the switching channel, the protocol and universe number, and the IP address of the control source. Click on the gearwheel icon to change these parameters.



The red warning triangle is a warning that the process engine cannot be configured without a Switch control source. This is to indicate that the control source has not been configured yet for the Switch. As soon as the control source has been configured this triangle will disappear.

Patch, Master/Limit and startup buffer options are available for this mode.

Control channel mapping:

000 - 007	Do Nothing/Idle (current active source stays active)
008 - 015	Input 1
016 - 023	Input 2
024 - 031	Input 3
032 - 039	Input 4
040 - 247	Future use
248 - 255	Do Nothing/Idle (current active source stays active)

CUSTOM

This mode is ideal for a complex setup, or when per channel control is needed. Custom offers you to choose what policy to apply for each channel, and to create a complete custom soft patch.

Depending on the mode chosen, up to four DMX, Art-Net, sACN, KiNET, RTTrPL, Internal or Play inputs can be merged in this policy.

The custom mode offers you to combine any mode or combination of modes including: Input 1 only, Input 2 only, Input 3 only, Input 4 only, LTP, HTP, X-Fade, Backup, and switch.

To get access to the custom patch panel, click on the patch icon.

From this panel, you can define the complete patch per input, with any merging policy, or control source.

Use the From To tool to quickly apply a merging policy or mode to a range of channels.

Once the merging policies have been applied to the DMX channels, you will be able to assign a remote-control channel.

Use the From To tool to quickly apply a control channel to a range of DMX channels. Press the **Apply** button to save your settings.

Backup time(ms) 400 **Auto recover**

Backup control source - 0 . 0 . 0 . 0

X-Fade control source ▲ - 0 . 0 . 0 . 0

Switch control source ▲ - 0 . 0 . 0 . 0

From 1 - 512 **To** 1 - 512 **Mode** LTP **Control channel** /

Channel	Input 1	Input 2	Input 3	Input 4	Mode	Control channel
1	1	1	1	1	LTP	/
2	2	2	2	2	LTP	/
3	3	3	3	3	LTP	/
4	4	4	4	4	LTP	/
5	5	5	5	5	LTP	/
6	6	6	6	6	LTP	/
7	7	7	7	7	LTP	/
8	8	8	8	8	LTP	/
9	9	9	9	9	LTP	/

PATCH OPTION

Depending on the selected mode you applied to your process engine, you will be able to modify the patch for your sources.

Once in the process engine panel, click on the patch icon to open the patch panel.

From there, you can apply the patch you wish per channel.

Press **Apply** to save your settings.

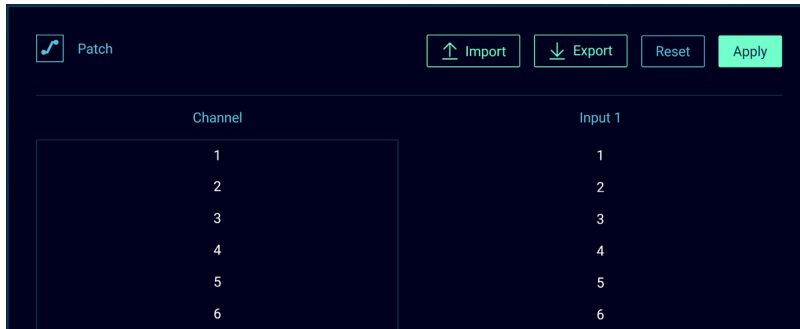

PATCH IMPORT/EXPORT

From firmware 2.2.0 LumiNode offers the option to import or export your patch. You can import a CSV or TSV file with your custom patch. The process engine will automatically configure the mode required based on your patch info.

To export a patch, open the patch option in the process engine configuration window and select **Export**. Choose a location to save the patch and choose Save. This can be an easy way to start a custom patch to have the correct format for the patch file that you want to import at a later stage with your custom data. Once you have the exported file, you can change it and then import it again.

To import a patch, open the patch option in the process engine configuration window and select **Import**. Browse to the file you wish to use on your computer and choose Open. The web-UI will refresh and show the Node configuration page. Now configure your input(s) and output(s) as normal.

MASTER/LIMIT OPTION

Depending on the selected mode you applied to your process engine, you will be able to assign a master or limit channel to your output.

Once in the process engine panel, click on the Master/Limit icon to open the configuration panel.

First select the mode you wish to use, by clicking on the Master/Limit switch, on the top left corner of the panel.

You can define the control channel, the protocol and universe number, as the IP address of the control source. Click on the gear wheel icon to change these parameters.

From there, you can apply any master /limit control channel to your output channels. This can be the same for all channels or different per channel or group of channels.

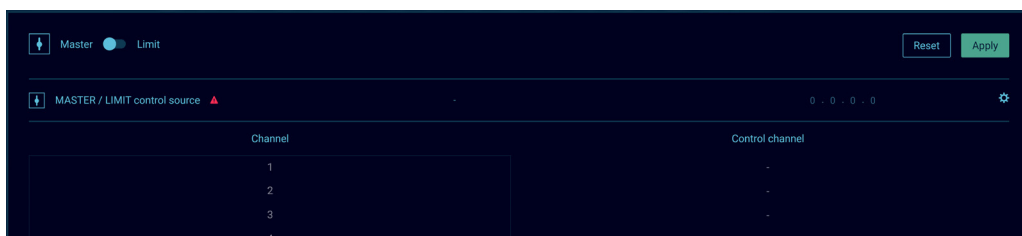

Press **Apply** to save your settings.

MASTER/LIMIT EXPLAINED:

Master:

When choosing the Master option, we configure a control channel to act like a grand master. The output is scaled to each individual channel. (Master value x Channel value / 255)

For example:

Channel 1 = 200

Channel 2 = 229

Channel 3 = 128

If we now reduce the master channel to 204, the channels will output as follows:

Channel 1 = 160

Channel 2 = 183

Channel 3 = 102

Example calculation: Channel 1 = $204 \times 200 / 255 = 160$

Limit:

When choosing the Limit option, we configure a control channel to set a limit to the output. There is no scaling applied to the channels.

For example:

Channel 1 = 191

Channel 2 = 153

Channel 3 = 128

If we now set the limit channel to be 178, the result will be as follows:

Channel 1 = 178

Channel 2 = 153

Channel 3 = 128

Example calculation: Channel 1 => $191 > 178 \Rightarrow 178$

As the result shows, channel 1 has been reduced but channels 2 and 3 have not been affected.

STARTUP BUFFER:

From firmware 2.4.0, LumiNode offers the option to set a startup buffer. This allows the user to configure values for each channel to be outputted from the LumiNode on bootup until the input source has been detected. As soon as the first frame from the input source is present on the input, the LumiNode will switch to the input source.

7. Technical Support

Sometimes it is required to get more help with your device or application. There is a knowledge base available online that gets updated on a regular basis at: <https://support.luminex.be>

If you need to ask our team for more help or you need to return a device to Luminex for diagnostics or repair, you can also find the option on this page to request an RMA or start a support ticket.

8. Credits

The following credits are available for this manual:

- Art-Net™ Designed by and Copyright Artistic Licence Holdings Ltd.



- ANSI E1.20 - 2010 Entertainment Technology RDM, Remote Device Management over DMX512 Networks.
- ANSI E1.31 - 2018 Entertainment Technology - Lightweight streaming protocol for transport of DMX512 using ACN.
- BlackTrax by Cast Software

9. Technical Specifications

CONNECTIVITY	
DMX/RDM	12x shielded & gold plated Neutrik 5 pin XLR (female)
Network	2x gigabit shielded Neutrik etherCON connector
Contact Closure	1x 2-pin plugable terminal block
Power	1x Neutrik powerCON TRUE1 (input & output) PoE-802.3af (Class 0)
DMX FEATURES	
Supported protocols	DMX512 (1986 & 1990) DMX512-A RDM ANSI E1.20-2010
DMX port direction	Input or output (configurable)
DMX port isolation	Optical and galvanic isolation per port
DMX timing	Framerate: 10-40FPS Break: 176-352µs
ETHERNET FEATURES	
Supported protocols	Art-Net™ (1-4) sACN ANSI E1.31-2018 RTTrPL (BlackTraX) KiNET v1, v2
Port speed	10/100/1000Mbps
Port sensing	Auto-negotiation MDI/MDIX
Split management interface	Yes
Groups (VLAN) support	Yes
ADDITIONAL FEATURES	
Process Engine	16
Merging	Yes (HTP, LTP, Xfade, Backup, Switch, Custom)
Softpatch	Yes
Master/Limit	Yes
Trigger system	Yes
Reroute function	Yes
Profile manager	Yes
Snapshot	Yes
Monitoring Software	LumiNet Monitor, Araneo
DMX redundancy	Yes
STATUS REPORTING	
Display & Jog	Yes
Ethernet port connection	Link/activity LED Group RGB LED
DMX port	DMX/RDM RGB LED
POWER/PoE	
Power input	100-240VAC 50-60Hz PoE-802.3af (Class 0)
Power consumption	Max 13W
Power redundancy	Yes

MANAGEMENT	
Configuration	Built in Web server Documented Web API Colour display & Jog
ENVIRONMENTAL	
Operating temperature	0 to +50°C
Storage temperature	-10 to +70°C
Humidity (non condensing)	5 to 95% RH
MECHANICAL	
Enclosure	Robust all metal housing
Dimensions (W x D x H)	482 x 150 x 44mm
Weight	1.96kg
Mounting type	Rack mount
Packaging	545 x 338 x 80mm
APPROVALS	
Electromagnetic emissions and immunity	EN55032 class A EN55035 EN61000-3-2 EN61000-3-3 EN61000-4-2 EN61000-4-4 EN61000-4-5 EN61000-4-6 EN61000-4-8 EN61000-4-11 FCC Part 15 CFR 47 class A ICES-003 Issue 6
Safety approvals	IEC 62368-1 EN 62368-1 UL 62368-1 CAN/CSA-C22.2 No. 62368-1 CE
Certificates	cSGSus Mark CE CB certificate
GREEN	
	RoHS REACH

DISCLAIMER

Luminex LCE operates a policy of continuous development. Luminex LCE reserves the right to make changes and improvements to any of the products described in this document above without prior notice. Specifications are subject to change without notice.

Copyright © 2002-2022.

All rights reserved.

No part of this documentation may be reproduced or transmitted in any form or by any means, electronic or mechanical, including photocopying and recording, without the prior written permission of Luminex. The information in this documentation is supplied without warranty of any kind, either directly or indirectly, and is subject to change without prior written notice. Luminex, its employees or appointed representatives will not be held responsible for any damages to software, hardware, or data, howsoever arising as a direct or indirect result of the product(s) mentioned herein.

Luminex
NETWORK INTELLIGENCE

YOUR NETWORK SOLUTION FOR
AUDIO, VIDEO AND LIGHTING

EFFECTIVE, RELIABLE, ACCESSIBLE



Luminex

Slamstraat 13 | 3600 Genk | Belgium | T +32 11 812 189 | info@luminex.be | www.luminex.be